

**Fixing Quantities**

Length of Nominal Dome Side (mm)	Number of fixings per side
600, 750	2
900, 1050, 1200	3
1350, 1500, 1650	4
1800, 1950	5
2100, 2250	6
2400	7

(All fixings supplied in packs of 5.)

**Installation Instructions**

**a** Install roof covering to cover existing upstand in accordance with manufacturer's installation recommendations.

**i** **N.B.** It is important that there should be no excessive build up of layers, the top surface should be level and free from any protrusions or projections which may prevent adequate weather proofing.

**b** Carefully remove dome from its packaging.

**c** Affix the supplied self adhesive seal to the underside of the flange on the dome.

**i** **N.B.** Protect top of dome using cloth, sheet or foam packaging.

**d** Pre-drill holes through dome on all sides at 5mm diameter.

See above **Fixing Quantities** table for the correct quantity of holes required for the size of the dome.

**i** **N.B.** Length of side refers to the nominal dome size (equivalent to external size of existing upstand.)

**e** Place dome squarely on top of the completed upstand.

**f** Fix the dome to the existing upstand. Use 55mm dome fastener with fastener button and both steel and foam washers.

**g** Fit fastener caps to each button.



**Mardome Contents**

**i** Please unpack and check that all correct parts are included and undamaged.

All Mardome Reflex

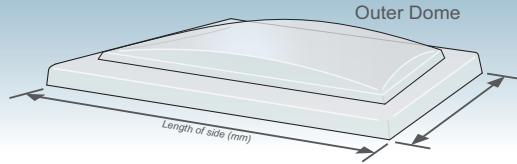

With this assembly, you will receive:  
**Reflex Dome Fixings and Accessories**

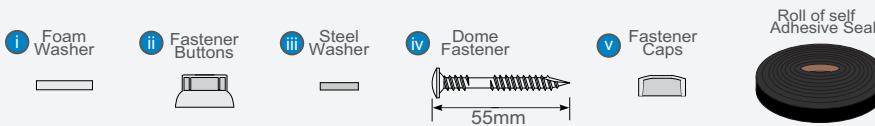

**Mardome Installation**

**i** Please note that all Health and Safety Regulations must be followed on site throughout the installation process.

**c Reflex Dome Adhesive Seal Application**

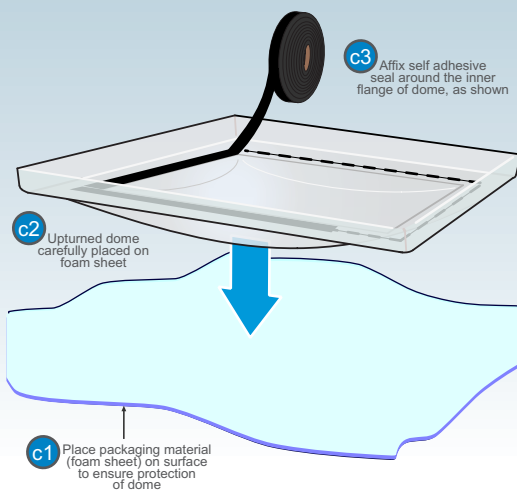

**Reflex dome on to existing upstand**

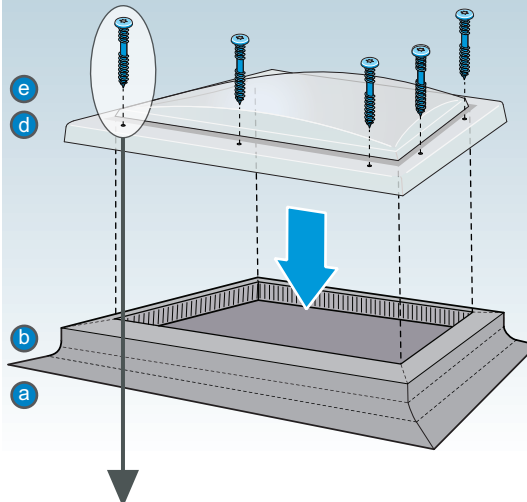

**Adhesive Seal and Dome Fixing**

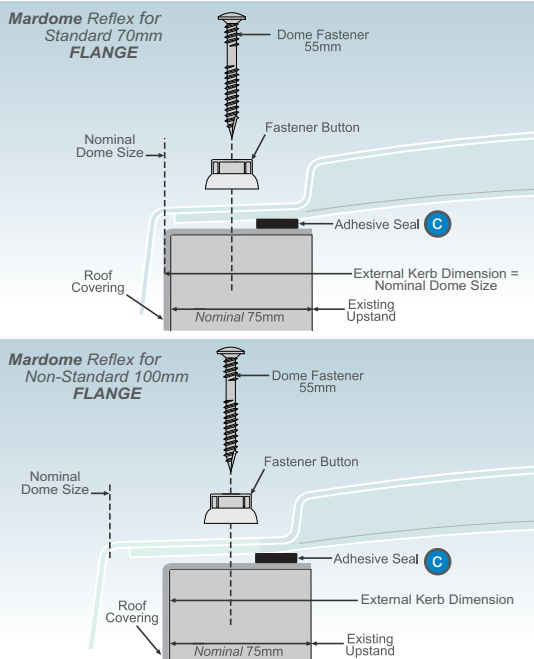

**Dome Installation Details**

**f 9** For All Reflex Domes

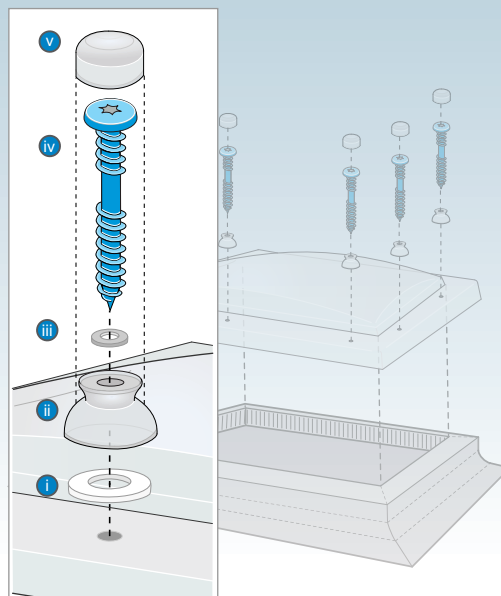

**TECHNICAL SUPPORT:** For any technical information/queries please contact your supplier.

### Fixing Quantities

Nominal Diameter of Dome (mm)	Number of fixings (minimum)
600	6
750	8
900	9
1050	10
1200	12
1350	14
1500	15
1800	20

(All fixings supplied in packs of 5.)

**i** Equal spacing between fixings approximately 300mm

### Installation Instructions

**!** ONLY use the fixings supplied!

**a** For circular dome on to existing upstand, go to e.  
Mastic/Silicone around the edge of the roof opening.

**b** Carefully remove dome from it's packaging.

**c** Correctly align sloping kerb assembly with internal roof aperture.

**d** Fix kerb to the roof using the 55mm kerb fastener.

See above **Fixing Quantities** table for the correct quantity of holes required for the size of the dome.

**e** Install roof covering to cover existing upstand or sloping kerb in accordance with manufacturer's installation recommendations.

**!** N.B. It is important that there should be no excessive build up of layers, the top surface should be level and free from any protrusions or projections which may prevent adequate weather proofing.

For circular dome on to sloping kerb, installation is now complete.

**f** Carefully remove dome from it's packaging and affix the supplied self adhesive seal to the underside of the flange of the dome.

**g** Pre-drill holes through dome at 5mm diameter.

See above **Fixing Quantities** table for the correct quantity of holes required for the size of the dome.

**h** Correctly align dome and place on top of the completed upstand.

**i** Fix the dome to the existing upstand using 55mm dome fastener with button and both steel and foam washers.

**j** Fit fastener caps to each fastener button.

## Mardome Contents

**i** Please unpack and check that all correct parts are included and undamaged.

### All Mardome Circular

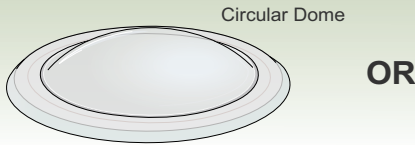

### Mardome Circular on sloping kerb

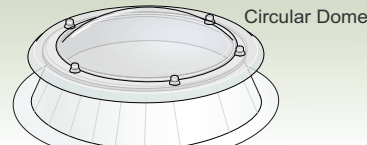

### With this assembly, you will receive: Circular Dome Fixings and Accessories

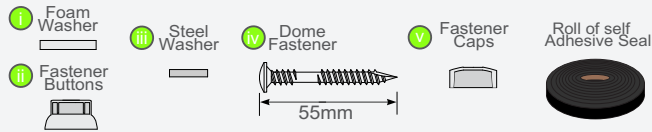

### With this assembly, you will receive: Kerb Fixing

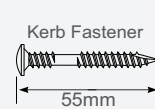

## Mardome Installation

**!** Please note that all Health and Safety Regulations must be followed on site throughout the installation process.

### f Circular dome on to existing upstand Adhesive Seal Application

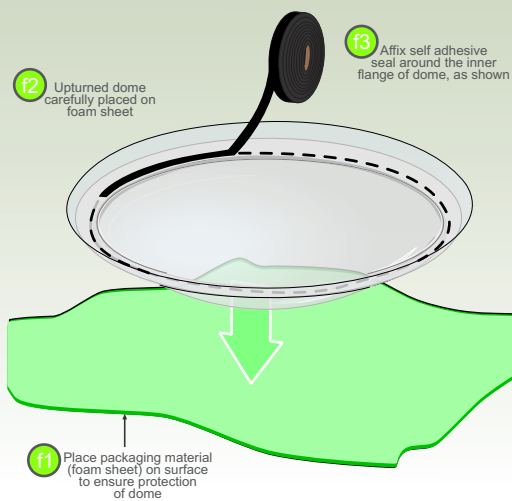

### Circular dome on to sloping kerb

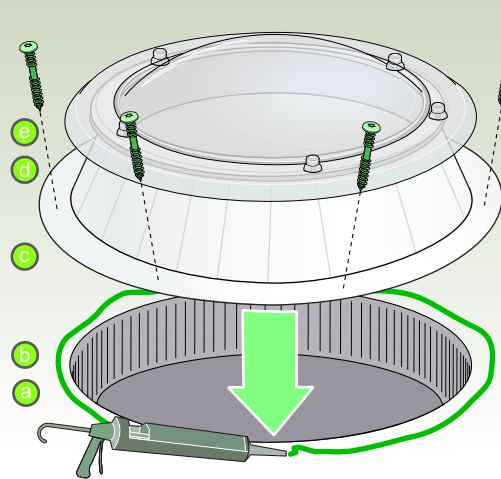

## Mardome Installation Continued

### Circular dome on to existing upstand

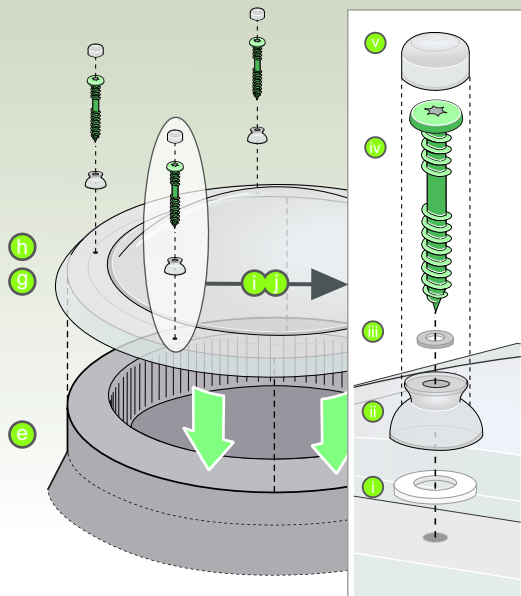

## Dome Fixing and Kerb Fixing

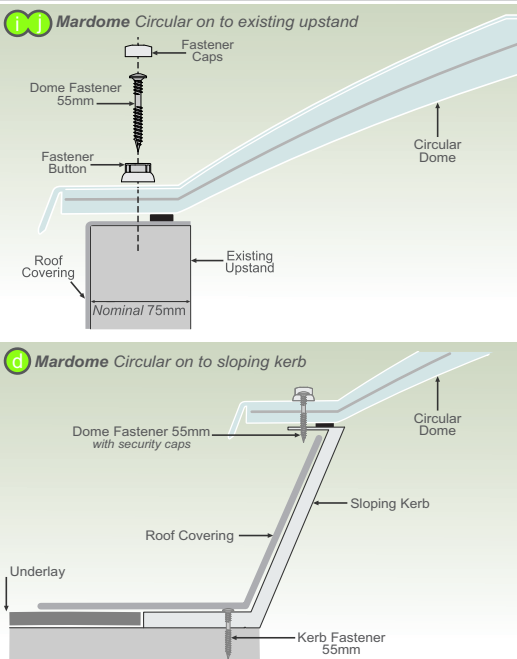

**!** TECHNICAL SUPPORT: For any technical information/queries please contact your supplier.

Brett Martin Daylight Systems operates a policy of continuous product improvement, and reserves the right to alter specifications at any time without notice. Every effort has been taken to ensure all details contained in this document are correct at the time of going to press but this document should be used only as a guide and does not in any way form part of a contract or warranty. It is the customer's responsibility to ensure that the product is suitable for the actual conditions of use, which are beyond the control of Brett Martin Daylight Systems.